

# SPEC



**DESIGNER AUDIO**

REAL-SOUND AMPLIFIER

RSA-BW7 **EX**

## Operation Manual

Read through this operation manual before use so you will know how to operate your model properly. After you have finished reading the manual, put it in a safe place for future reference.



# Safety Precautions

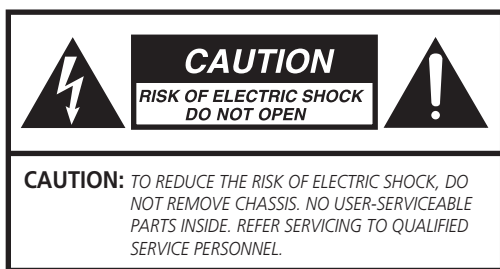

**AVIS: RISQUE DE CHOC ELECTRIQUE-NE PAS OUVRIIR.**



THIS SYMBOL IS INTENDED TO ALERT THE USER TO THE PRESENCE OF NON-INSULATED "DANGEROUS VOLTAGE" WITHIN THE PRODUCTS ENCLOSURE THAT MAY BE OF SUFFICIENT MAGNITUDE TO CONSTITUTE A RISK OF ELECTRIC SHOCK TO PERSONS.



THIS SYMBOL IS INTENDED TO ALERT THE USER TO THE PRESENCE OF IMPORTANT OPERATING AND MAINTENANCE (SERVICING) INSTRUCTIONS IN THE LITERATURE ACCOMPANYING THE UNIT.

## WARNING

Exposure to extremely high noise levels may cause a permanent hearing loss.

Individuals vary considerably to noise induced hearing loss but nearly everyone will lose some hearing if exposed to sufficiently intense noise for a sufficient time.

## Operating Environment

Operating environment temperature and humidity: +5°C to +35°C (+41°F to +95°F); less than 85%RH (cooling vents not blocked)

Do not install this unit in a poorly ventilated area, or in locations exposed to high humidity or direct sunlight (or strong artificial light)

## WARNING

**This equipment is not waterproof. To prevent a fire or shock hazard, do not place any container filled with liquid near this equipment (such as a vase or flower pot) or expose it to dripping, splashing, rain or moisture.**

## POWER-CORD CAUTION

Handle the power cord by the plug. Do not pull out the plug by tugging the cord and never touch the power cord when your hands are wet as this could cause a short circuit or electric shock. Do not place the unit, a piece of furniture, etc., on the power cord, or pinch the cord. Never make a knot in the cord or tie it with other cords. The power cords should be routed such that they are not likely to be stepped on. A damaged power cord can cause fire or give you an electrical shock.

Check the power cord once in a while.

## European model only



If you want to dispose this product, do not mix it with general household waste. There is a separate collection system for used electric products in accordance with legislation that requires proper treatment, recovery and recycling.

Private households in the member states of the EU, in Switzerland and Norway may return their used electric products free of charge to designated collection facilities or to a retailer (if you purchase a similar new one).

For countries not mentioned above, please contact your local authorities for the correct method of disposal.

By doing so you will ensure that your disposed product undergoes the necessary treatment, recovery and recycling and thus prevent potential negative effects on the environment and human health.

# Contents

---

## Chapter 1 Introduction

Check included items .....	4
Installing this product .....	4
Regarding installation .....	4

## Chapter 2 Connections

Connections diagram .....	5
How to connect the speaker cords .....	6
How to connect XLR cables .....	6
How to connect audio cords .....	7
How to connect the power cord .....	7

## Chapter 3 Part Names

Front panel .....	8
Rear panel .....	9

## Chapter 4 How to Operate

Playback steps .....	10
----------------------	----

## Chapter 5 Other

Troubleshooting .....	11
Care and maintenance .....	11
Specifications .....	12
Separately sold accessories .....	12
Warranty and after sales service .....	13

# Chapter 1 Introduction

---

## Check included items

---

- Power cord × 1
- Operation manual (this book)

## Installing this product

---

- Be sure to install this product on a flat, stable surface.
- Do not install this product in the following locations:
  - On top of a television (the image may warp)
  - Near a cassette deck or other magnetism emitting device (the audio may be adversely affected)
  - In a location hit by direct sunlight
  - In a moist location
  - In high or low temperature locations
  - In a location with vibration
  - In a location with much dust or tobacco smoke
  - In kitchens or other locations where fumes are emitted and oil is used

## Regarding installation

---

### **Caution**

- Never place items on top of this product, cover it with a sheet, or use it when its heat radiation is obstructed. Abnormally high temperatures may damage the product.

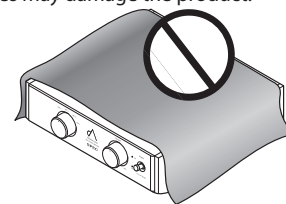

## Chapter 2

## Connections

## Connections diagram

 **Important**

- When connecting devices or making changes, be sure to turn the POWER switch OFF and disconnect the power cord from the electrical outlet. Plug in the power cord last.
- If an extremely loud signal is input to this product, there is a danger that noise will be generated and cause damage. In such a case, lower the input signal level.

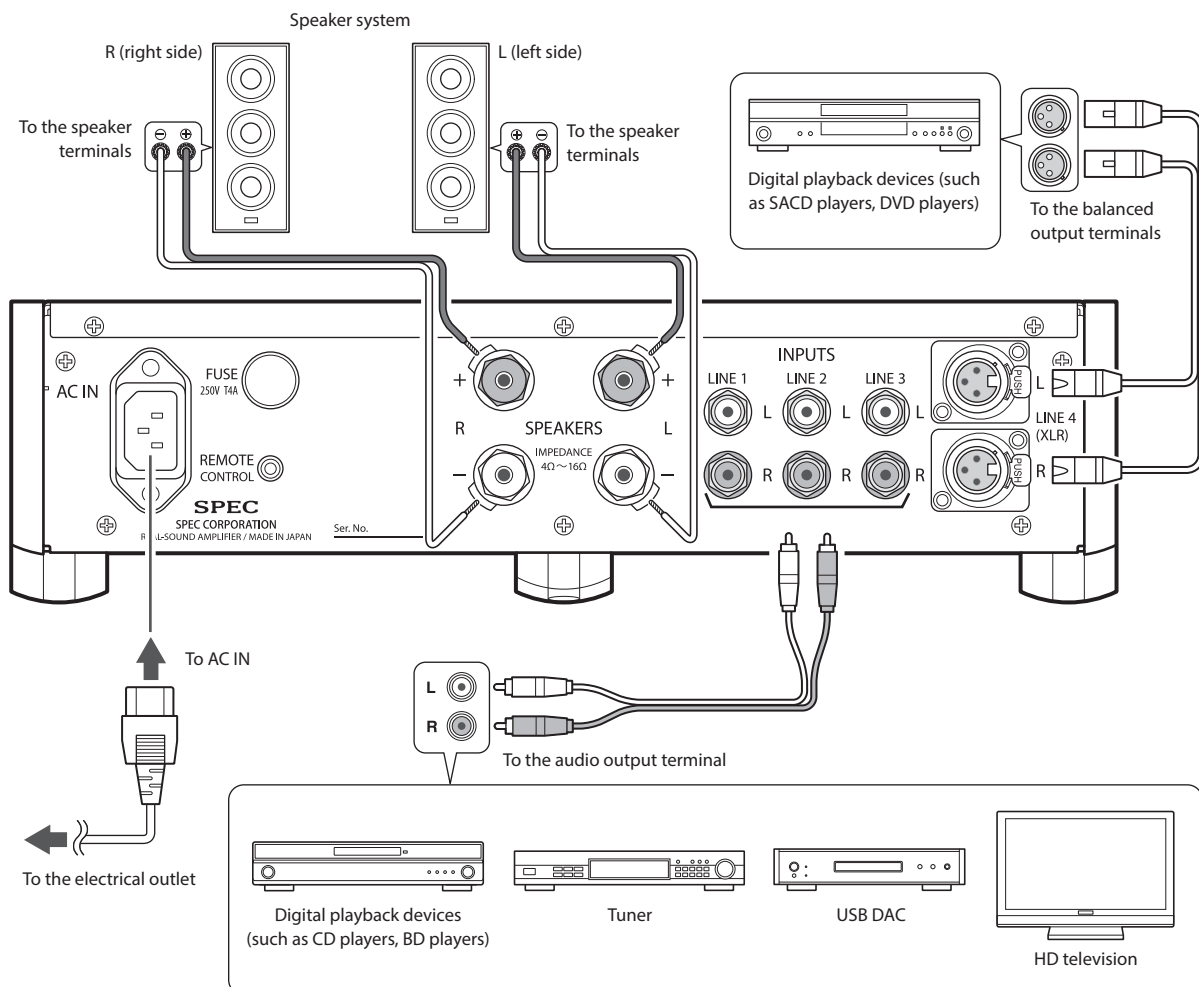

## How to connect the speaker cords

The connection terminals are red for positive (+) and black for negative (-).

- 1 Twist the wire.
- 2 Loosen the speaker terminal, and insert the speaker cord.
- 3 Once the speaker cord is inserted, tighten and secure the speaker terminal.

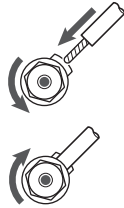

The connection terminals on this product are also compatible with Y lug terminals and banana plugs.

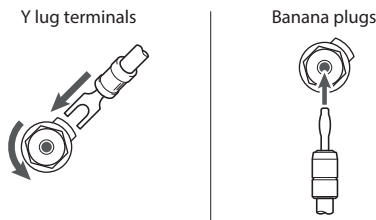

### **Caution**

- Use speakers with nominal impedance of 4Ω to 16Ω.
- Connect accurately the + and - terminals between the speakers and this product.
- Do not allow unshielded center wire from the terminals to stick out and make contact with each other. If the center wires touch the device may break.
- Use sufficient current capacity speaker cord and be sure to make connections that are not loose and do not short. Using low current capacity connecting cords or making imperfect connections may affect playback audio and can cause overheating or short circuits.
- High voltage is output from the speaker terminals. To avoid the danger of electrical shock, be sure to unplug the power cord before making speaker connections.

## How to connect XLR cables

Connect the left and right XLR input terminals of this product to the respective left and right balanced output terminals of the product to be connected.

Match the orientation of the XLR plug to this product's XLR input terminal, and insert until a click is heard.

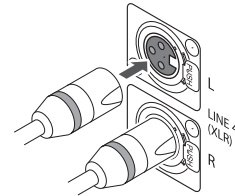

When disconnecting an XLR plug, press the latch lever (the part with "PUSH" inscribed on it) while pulling the cable. Use caution, as forceful disconnection may damage the unit.

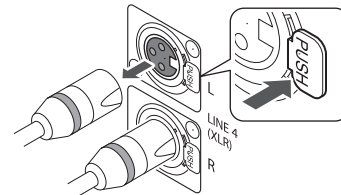

### **Note**

- The pin positioning of the XLR input terminal of this product is depicted below. Confirm that the product to be connected is compatible with the pin positioning of this product. For further details, consult the operation manual included with the product to be connected.

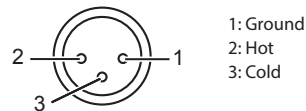

## How to connect audio cords

Connect the white RCA plug (left) to the left side input terminal with the white line, and the red RCA plug (right) to the right side input terminal with the red line. Press firmly to push the plugs all the way in.

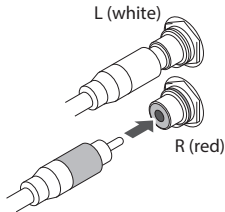

## How to connect the power cord

Once all connections have been made, connect the included power cord to the AC IN terminal of this product and to the residential electrical outlet. Press firmly to push the plug all the way in.

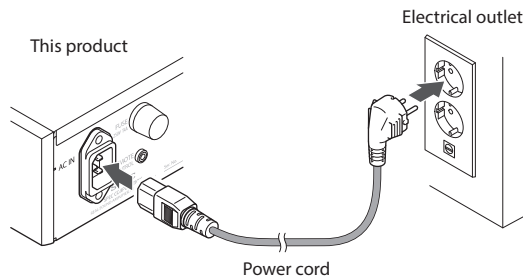

\* The plug type varies according to the region.

## **Caution**

- The power cord for this product is removable, but please refrain from using power cords other than the cord included (3P plug-in socket type with electrical current capacity: 7A).
- Never insert the ground wire from the AC CONVERSION PLUG into the electrical outlet.

## **Note**

- When not using this product for extended periods, be sure to turn the POWER switch OFF or unplug the power cord from the electrical outlet.
- Turn the POWER switch OFF before unplugging the power cord.
- The power consumption of this product varies greatly depending on the volume level of the playback audio signal. For satisfactory music playback, connect to an electrical outlet with sufficient capacity. (Connecting to a low capacity electrical outlet creates the danger that the connection will overheat.)
- If the residential power supply is cut off due to a power outage, the state of this product will be as follows when power is restored.
  - If the POWER switch is ON when power is restored
    - The product returns to its state prior to power restoration.
  - If the POWER switch is OFF when power is restored
    - The product is in the normal power OFF state.

## Front panel

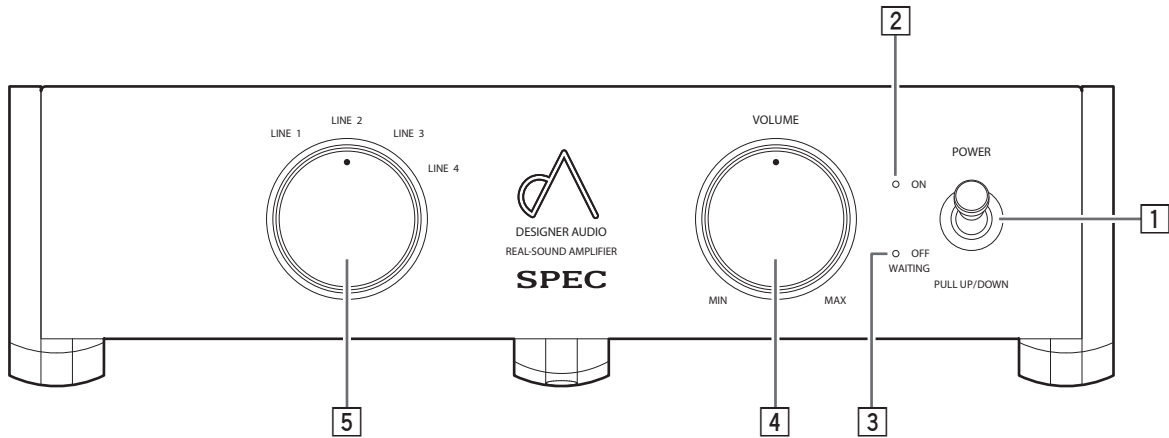

**1 POWER switch**

Turns power ON and OFF.

Pulling the power switch releases the lock. To turn on the power, raise up the power switch while pulling out on it. To turn off the power, lower the power switch while pulling out on it.

**2 ON indicator**

Shines warm yellow when this product is on.

**3 OFF (WAITING) indicator**

Shines red for several seconds following power-up. Once the product is operational, this indicator turns off and the ON indicator shines warm yellow. It also flashes for several tens of seconds when the power is shut off. During this time this product is preparing to power off, so please wait until the indicator light goes out.

**4 VOLUME (level adjustment knob)**

Adjusts the volume level.

**Note**

- This product contains a high quality electrical volume IC that is high precision and ultra low noise, with the result that audio quality is not affected depending on the VOLUME (level adjustment knob) position.

**5 LINE SELECTOR (input switching knob)**

Selects the playback device (LINE 1-LINE 4).

**Caution**

- When turning the product on immediately after turning it off, check to make sure that the OFF (WAITING) indicator has turned off completely. Turning the power on while the OFF (WAITING) indicator is lit can cause malfunction.



## Rear panel

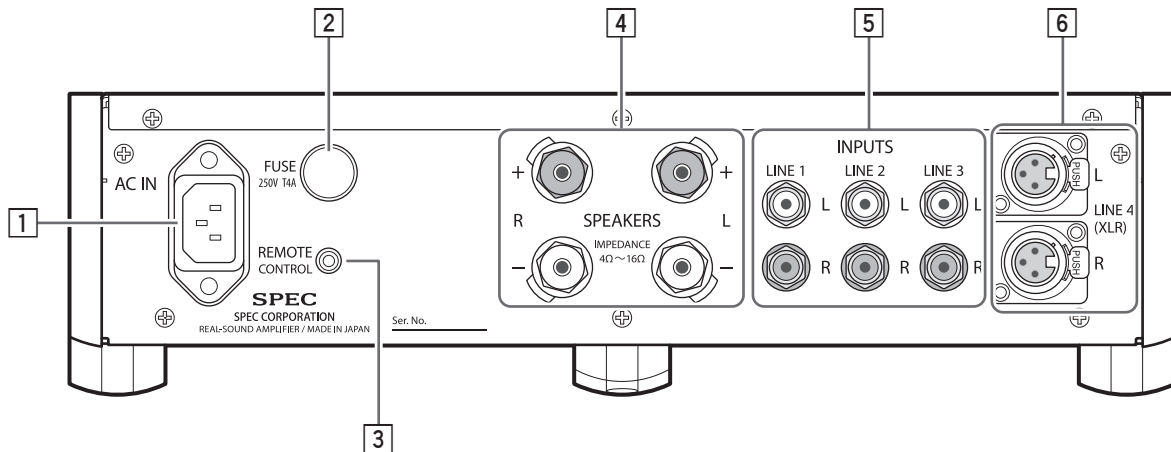

- ① **AC IN terminal**  
Connect the included power cord. (→ pages 5, 7)
- ② **Fuse**  
The fuse may break if something abnormal occurs to the product. Contact us if the fuse breaks. (→ page 13)
- ③ **REMOTE CONTROL terminal**  
Connect the (separately sold) remote control. Contact us for details regarding the (separately sold) remote control. (→ page 12)
- ④ **Speaker terminal (R (right) channel)  
Speaker terminal (L (left) channel)** (→ pages 5 to 6)
- ⑤ **Audio input terminals (LINE 1 - LINE 3)**  
RCA type input terminal. (→ pages 5, 7)
- ⑥ **XLR input terminal (LINE4)**  
XLR type input terminal (female). (→ pages 5 to 6)

## Playback steps

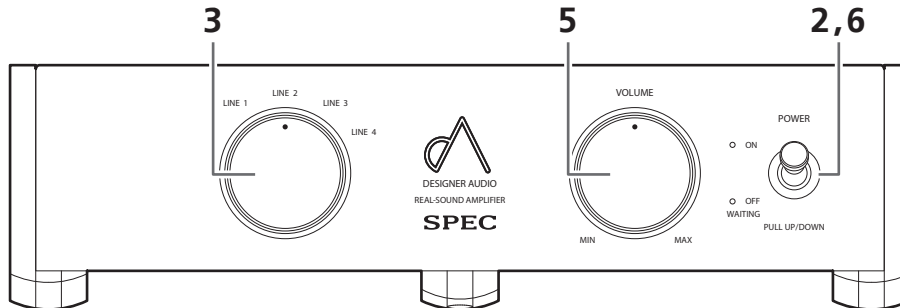

- 1 Turn on the power of the playback device.
- 2 Check that the volume level of this product is turned down, and lift up the front panel POWER switch while pulling out on it to turn on the power.

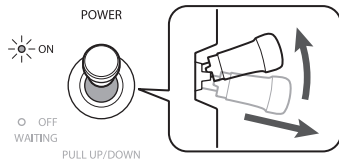

Check that the ON indicator on the body front panel is lit.

- 3 Select the input to this product.

Rotate the LINE SELECTOR to select the terminal (LINE 1 - LINE 4) to which the playback device is connected.

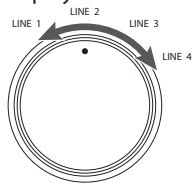

- 4 Operate the playback device and begin playback.

- 5 Rotate the VOLUME (level adjustment knob) left and right to set the audio level.

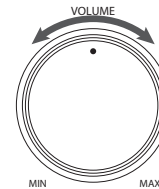

- 6 When playback is finished, lower the audio volume level and push down the front panel POWER switch while pulling out on it to turn off the power.

Be sure to lower the audio volume level.

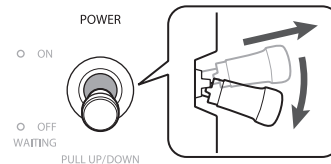

### Caution

- When turning the product on immediately after turning it off, check to make sure the OFF (WAITING) indicator has gone off completely. (→ page 8)

### Troubleshooting

If you think this product may be broken, check the following troubleshooting items. Some minor operational errors can make the product appear to be broken.

Potential causes other than this product should also be considered. Check the other devices being used as well as all simultaneously operated electrical devices. If the following instructions do not help even on multiple inspections, contact us. (→ page 13)

Issue	Cause/Treatment	Reference
The power does not turn on.	<ul style="list-style-type: none"> <li>Is the power plug disconnected from the electrical outlet? → Correctly insert the power plug into the outlet.</li> </ul>	p. 7
	<ul style="list-style-type: none"> <li>Is the power plug disconnected from the AC IN terminal? → Correctly insert the power plug.</li> </ul>	p. 7
	<ul style="list-style-type: none"> <li>If the power will not turn on even with correctly connecting the power plug, the fuse may be broken. → Contact us for consultation.</li> </ul>	p. 13
There is no sound.	<ul style="list-style-type: none"> <li>Is the connecting cord disconnected from the terminal, or connected incorrectly? → Correctly connect the cord.</li> </ul>	p. 5 - p. 7
	<ul style="list-style-type: none"> <li>Is the speaker cord disconnected from the terminal, or connected incorrectly? → Correctly connect the speaker cord.</li> </ul>	p. 5 - p. 6
	<ul style="list-style-type: none"> <li>Is the terminal or connecting cord pin plug dirty? → Wipe clean the terminal or plug.</li> </ul>	-
	<ul style="list-style-type: none"> <li>Is the input (LINE 1 - LINE 4) of this product incorrectly set for the playback device? → Correctly select the input.</li> </ul>	p. 5
There is no sound from one speaker.	<ul style="list-style-type: none"> <li>Is the connecting cord or speaker cord for one side disconnected? → Correctly connect the cord.</li> </ul>	p. 5 - p. 7
Sound comes out of the speakers even after turning off this product.	<ul style="list-style-type: none"> <li>Immediately after turning off the power, sound may come out of the speakers while the OFF (WAITING) indicator is lit, but this is not a sign of breakage. → When playback is finished, first turn the volume of this product all the way down and then shut off the power of this product.</li> </ul>	p. 8

### Care and maintenance

For daily maintenance, use a polishing cloth to lightly wipe the front panel of this product. If it is very dirty, use a soft cloth moistened with neutral detergent watered down to 1/5-1/6 concentration and wipe off the dirt, then wipe dry with a dry cloth. If alcohol, thinner, petroleum ether or insecticide adhere to the front panel it may be damaged, so use caution. Whenever using pre-moistened wipe, be sure to completely read the warning instructions that come with the wipe.

This product uses natural wood for its side panel and insulator. Do not place it in direct sunlight or near a heater. The front panel may become discolored, and the product may be warped due to the natural wood contracting.

## Specifications

---

### ■ Amplifier

Maximum output .....	100W × 2 (4Ω)
Frequency response .....	10 Hz - 30 kHz ±1 dB (6Ω, 1W)
Harmonic distortion ratio.....	0.02 % (at 1 kHz, 80% output)
Input sensitivity, gain.....	300 mVrms, 37.3 dB (at MAX volume, 6Ω, 1 kHz, unbalanced input)
Line input terminals .....	Balanced input: 1 RCA unbalanced inputs: 3
Speaker terminal .....	1

### ■ Power supply, other

Power voltage.....	110, 120, 220, 230, 240 V AC, 50 Hz/60 Hz
Electrical consumption .....	With no signal: 9 W, during maximum output: 150 W
External dimensions.....	350 mm (width) × 95 mm (height) × 375 mm (depth)
Weight .....	6.5 kg

### ■ Included items

Power cord.....	1
Operation manual (this book) .....	1

\* Due to improvements the above specifications and external appearance may be changed without notice.

## Separately sold accessories

---

The following separately sold accessories are available.

### ■ Remote control

Remote control sold separately.  
For details please contact us.

## Warranty and after sales service

### ● About Warranty

Make sure that the name of your distributor and the date of purchase are written in the warranty. Read it carefully, and then keep it in a secure location. The warranty is valid for one year from the date of purchase.

### ● Malfunctions

If the product malfunctions in the course of normal use (use in accordance with the manual and safety precautions) during the warranty period, then we will repair the product free of charge. When you bring your product to the distributor for servicing, be sure to bring the warranty with you. See the guarantees in your warranty for details. We will repair malfunctions occurring after the warranty period has expired for a fee, in accordance with our servicing regulations.

**Please note that we cannot provide any warranty or bear any liability for damage to any equipment that is connected to the unit resulting from incorrect use.**

#### Contact Information

##### SPEC CORPORATION

TEL: +81-3-3660-0303

FAX: +81-3-3660-0333

E-mail: info-ex@spec-corp.co.jp

URL : spec-corp.co.jp

### Terms of Warranty

1. If this product malfunctions during use in accordance with the manual, and during the warranty period, then please bring the product and this warranty to the store where you purchased it. It will be repaired free of charge.
2. If you cannot ask the store where you purchased it for repairs (e.g. if you have moved or the product was a gift), please consult with SPEC CORPORATION.
3. A fee will be charged for repairs in the following circumstances, even if it is during the warranty period.
  - (A) The product malfunctioned or was damaged due to user error or unauthorized repair or modification
  - (B) The product malfunctioned or was damaged due to dropping, etc. after purchase
  - (C) The product malfunctioned or was damaged due to fire, flooding, lightning and other weather phenomena, pollution, salt damage, or the like
  - (D) The product malfunctioned or was damaged due to other than normal use, such as long hours of continuous commercial use
  - (E) The main unit has been disassembled
  - (F) The text of the warranty has been changed or overwritten
  - (G) The malfunction was caused by another company's product
4. This warranty cannot be re-issued. Store it in a safe place, and do not lose it.

## WARRANTY

RSA-BW7EX Receiver and Amplifier

Name	Telephone ( )
Address	
Date of Purchase	Distributor Name & Telephone
Warranty Period (Months) <b>One Year</b> Date of Purchase	





# SPEC

SPEC CORPORATION

4th FL.NIHOMBASHI NAKAYA BUILDING,12-12 NIHOMBASHI-  
KOBUNA-CHO,CHUO-KU,TOKYO 103-0024,JAPAN

© SPEC 2023